

JVC

SCHEMATIC DIAGRAMS

COLOR TELEVISION

BASIC CHASSIS

FV4

AV-27220_{/R}

AV-27220_{/S}

CD-ROM No.SML200102

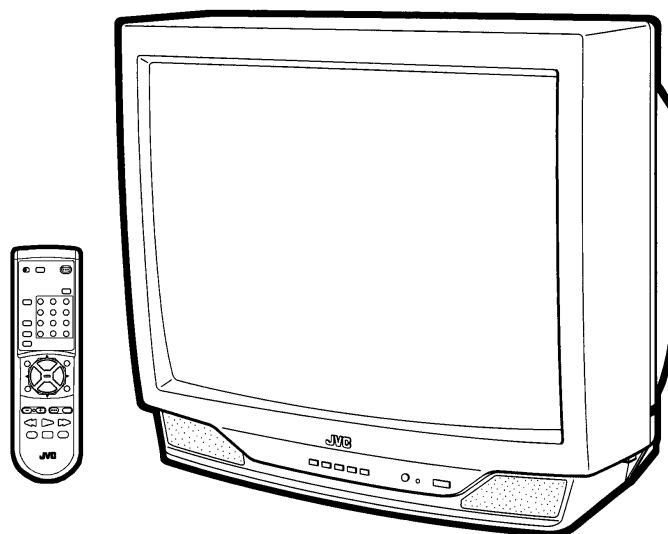

CONTENTS

■ NOTE ON USING CIRCUIT DIAGRAMS	2-1
■ SEMICONDUCTOR SHAPES	2-2
■ BLOCK DIAGRAMS	2-3
■ CIRCUIT DIAGRAMS	2-5
■ PATTERN DIAGRAMS	2-17
■ CHANNEL CHART	2-19

CHANNEL CHART [CA]

MODE		BAND	CHANNEL		TUNER BAND
TV	CATV		REAL	DISP.	
○	○	VL	02	I	
			03		
			04		
			05		
			06		
			07		
	○	VH	08	II	
			09		
			10		
			11		
			12		
			13		
			x		○
B 15					
C 16					
D 17					
E 18					
F 19					
G 20					
H 21					
I 22					
○	SUPER	J 23		III	
		K 24			
		L 25			
		M 26			
		N 27			
		O 28			
		P 29			
		Q 30			
		R 31			
○	HYPER	W+1 37		III	
		W+2 38			
		W+3 39			
		W+4 40			
		W+5 41			
		W+6 42			
		W+7 43			
		W+8 44			
		W+9 45			
		W+10 46			
○	ULTRA	W+11 47	IV		
		W+12 48			
		W+13 49			
		W+14 50			
		W+15 51			
		W+16 52			
		W+17 53			
		W+18 54			
○	ULTRA	W+19 55	IV		
		W+20 56			
		W+21 57			
		W+22 58			
		W+23 59			
		W+24 60			
○	ULTRA	W+25 61	IV		
		W+26 62			
		W+27 63			
		W+28 64			
		W+29 65			
		W+30 66			
○	ULTRA	W+31 67	IV		
		W+32 68			
		W+33 69			
		W+34 70			

MODE		BAND	CHANNEL		TUNER BAND
TV	CATV		REAL	DISP.	
x	○	ULTRA	W+35 71	IV	
			W+36 72		
			W+37 73		
			W+38 74		
			W+39 75		
			W+40 76		
			W+41 77		
			W+42 78		
			W+43 79		
			W+44 80		
			W+45 81		
			W+46 82		
			W+47 83		
			W+48 84		
			W+49 85		
			W+50 86		
			W+51 87		
			W+52 88		
			W+53 89		
			W+54 90		
			W+55 91		
			W+56 92		
			W+57 93		
			W+58 94		
			W+59 100		
			W+60 101		
			W+61 102		
			W+62 103		
			W+63 104		
			W+64 105		
			W+65 106		
			W+66 107		
			W+67 108		
			W+68 109		
			W+69 110		
			W+70 111		
			W+71 112		
			W+72 113		
			W+73 114		
			W+74 115		
			W+75 116		
			W+76 117		
			W+77 118		
			W+78 119		
W+79 120					
W+80 121					
W+81 122					
W+82 123					
W+83 124					
W+84 125					
○	x	SUB MID	A-8 01	I	
			A-4 96		
			A-3 97		
			A-2 98		
○	x	UHF	14	IV	
			69		
TOTAL 180CH { VHF 124CH { UHF 56CH					
NOTE: TO RECEIVE THE SUBSCRIPTION OR PREMIUM PROGRAMMING FROM CERTAIN CABLE COMPANIES. SPECIAL ADAPTERS MAY BE REQUIRED.					

AV-27220_R / AV-27220_S STANDARD CIRCUIT DIAGRAM

NOTE ON USING CIRCUIT DIAGRAMS

1. SAFETY

The components identified by the Δ symbol and shading are critical for safety. For continued safety replace safety critical components only with manufactures recommended parts.

2. SPECIFIED VOLTAGE AND WAVEFORM VALUES

The voltage and waveform values have been measured under the following conditions.

- (1) Input signal : Color bar signal
 - (2) Setting positions of each knob/button and variable resistor : Original setting position when shipped
 - (3) Internal resistance of tester : DC 20k Ω / V
 - (4) Oscilloscope sweeping time : H \Rightarrow 20 μ S/div
 : V \Rightarrow 5mS/div
 : Others \Rightarrow Sweeping time is specified
 - (5) Voltage values : All DC voltage values
- * Since the voltage values of signal circuit vary to some extent according to adjustments, use them as reference values.

3. INDICATION OF PARTS SYMBOL [EXAMPLE]

● In the PW board : R1209 \rightarrow R209

4. INDICATIONS ON THE CIRCUIT DIAGRAM

(1) Resistors

- Resistance value
 - No unit : [Ω]
 - K : [K Ω]
 - M : [M Ω]
- Rated allowable power
 - No indication : 1/10[W]
 - Others : As specified

● Type

- No indication : Carbon resistor
- OMR : Oxide metal film resistor
- MFR : Metal film resistor
- MPR : Metal plate resistor
- UNFR : Uninflammable resistor
- FR : Fusible resistor

* Composition resistor 1/2 [W] is specified as 1/2S or Comp.

(2) Capacitors

- Capacitance value
 - 1 or higher : [pF]
 - less than 1 : [μ F]
- Withstand voltage
 - No indication : DC50[V]
 - AC indication : AC withstand voltage [V]
 - Others : DC withstand voltage [V]

* Electrolytic Capacitors
 47/50[Example]: Capacitance value [μ F]/withstand voltage[V]

- Type
 - No indication : Ceramic capacitor
 - MY : Mylar capacitor
 - MM : Metalized mylar capacitor
 - PP : Polypropylene capacitor
 - MPP : Metalized polypropylene capacitor
 - MF : Metalized film capacitor
 - TF : Thin film capacitor
 - BP : Bipolar electrolytic capacitor
 - TAN : Tantalum capacitor

(3) Coils

- No unit : [μ H]
- Others : As specified

(4) Power Supply

- : B1
- : 12V
- : 9V
- : 5V

* Respective voltage values are indicated

(5) Test point

- : Test point
- : Only test point display

(6) Connecting method

- : Connector
- : Wrapping or soldering
- : Receptacle

(7) Ground symbol

- : LIVE side ground
- : ISOLATED(NEUTRAL) side ground
- : EARTH ground
- : DIGITAL ground

5. NOTE FOR REPAIRING SERVICE

This model's power circuit is partly different in the GND. The difference of the GND is shown by the LIVE : (\perp) side GND and the ISOLATED(NEUTRAL) : (\neq) side GND. Therefore, care must be taken for the following points.

- (1) Do not touch the LIVE side GND or the LIVE side GND and the ISOLATED(NEUTRAL) side GND simultaneously. If the above caution is not respected, an electric shock may be caused. Therefore, make sure that the power cord is surely removed from the receptacle when, for example, the chassis is pulled out.
- (2) Do not short between the LIVE side GND and ISOLATED(NEUTRAL) side GND or never measure with a measuring apparatus (oscilloscope, etc.) the LIVE side GND and ISOLATED(NEUTRAL) side GND at the same time. If the above precaution is not respected , a fuse or any parts will be broken.

◇ Since the circuit diagram is a standard one, the circuit and circuit constants may be subject to change for improvement without any notice.

CONTENTS

SEMICONDUCTOR SHAPES 2-2

BLOCK DIAGRAM..... 2-3

CIRCUIT DIAGRAMS

MAIN PWB CIRCUIT DIAGRAM..... 2-5

MAIN PWB, CRT SOCKET PWB CIRCUIT DIAGRAM 2-15

PATTERN DIAGRAMS

MAIN PWB, CRT SOCKET PWB PATTERN 2-17

CHANNEL CHART..... 2-19

SEMICONDUCTOR SHAPES

TRANSISTOR

BOTTOM VIEW	FRONT VIEW				TOP VIEW
					CHIP TR

IC

BOTTOM VIEW	FRONT VIEW			TOP VIEW

CHIP IC

TOP VIEW	

CHANNEL CHART [US]

MODE		BAND	CHANNEL		TUNER BAND	
TV	CATV		REAL	DISP.		
○	○	VL	02	I		
			03			
			04			
			05			
			06			
		VH	07	II		
			08			
			09			
			10			
			11			
			12			
			13			
			x		○	MID
B 15						
C 16						
D 17						
E 18						
F 19						
G 20						
H 21						
I 22						
SUPER	J 23	II				
	K 24					
	L 25					
	M 26					
	N 27					
	O 28					
	P 29					
	Q 30					
	R 31					
	S 32					
	T 33					
	U 34					
	V 35					
	W 36					
	HYPER			W+1 37		IV
				W+2 38		
				W+3 39		
W+4 40						
W+5 41						
W+6 42						
W+7 43						
W+8 44						
W+9 45						
W+10 46						
W+11 47						
ULTRA	W+12 48	IV				
	W+13 49					
	W+14 50					
	W+15 51					
	W+16 52					
	W+17 53					
	W+18 54					
	W+19 55					
	W+20 56					
	W+21 57					
	W+22 58					
	W+23 59					
W+24 60						
W+25 61						
W+26 62						
W+27 63						
W+28 64						
W+29 65						
W+30 66						
W+31 67						
W+32 68						
W+33 69						
W+34 70						

MODE		BAND	CHANNEL		TUNER BAND				
TV	CATV		REAL	DISP.					
x	○	ULTRA	W+35 71	IV					
			W+36 72						
			W+37 73						
			W+38 74						
			W+39 75						
			W+40 76						
			W+41 77						
			W+42 78						
			W+43 79						
			W+44 80						
			W+45 81						
			W+46 82						
			W+47 83						
			W+48 84						
			W+49 85						
			W+50 86						
			W+51 87						
			W+52 88						
			W+53 89						
			W+54 90						
			W+55 91						
			W+56 92						
			W+57 93						
			W+58 94						
			W+59 100						
			W+60 101						
			W+61 102						
			W+62 103						
			W+63 104						
			W+64 105						
			W+65 106						
			W+66 107						
			W+67 108						
			W+68 109						
			W+69 110						
			W+70 111						
			W+71 112						
			W+72 113						
			W+73 114						
			W+74 115						
			W+75 116						
			W+76 117						
			W+77 118						
			W+78 119						
			W+79 120						
			W+80 121						
			W+81 122						
			W+82 123						
			W+83 124						
			W+84 125						
			SUB MID		A-8 01	I			
					A-4 96				
					A-3 97				
					A-2 98				
					A-1 99				
			○		x	UHF	14 } 69	IV	
			TOTAL 180CH { VHF 124CH UHF 56CH						
			NOTE: TO RECEIVE THE SUBSCRIPTION OR PREMIUM PROGRAMMING FROM CERTAIN CABLE COMPANIES. SPECIAL ADAPTERS MAY BE REQUIRED.						

BLOCK DIAGRAM

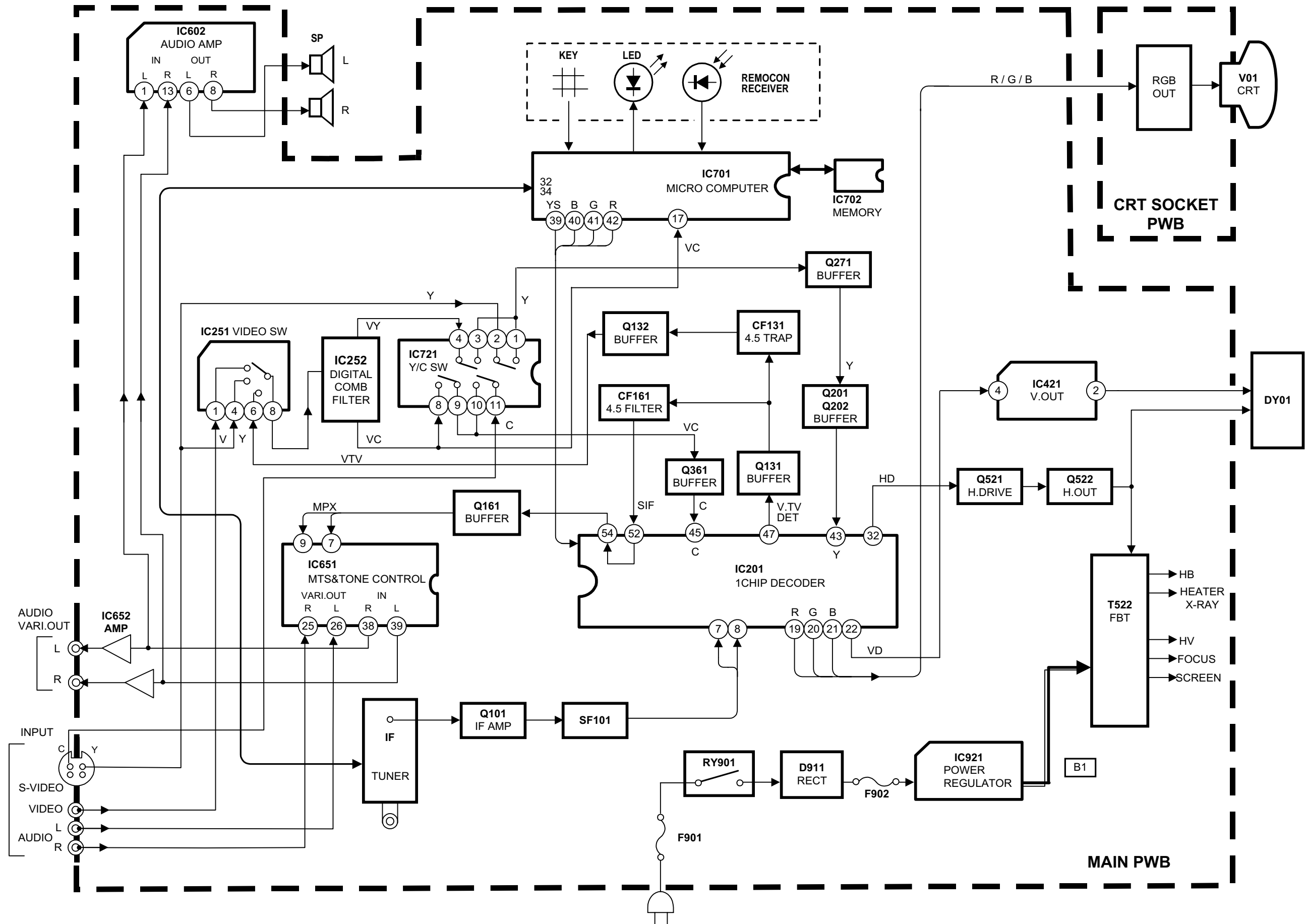

CIRCUIT DIAGRAMS MAIN PWB CIRCUIT DIAGRAM

(A See,Page 2-7,2-8)

(B See,Page 2-9,2-10)

MAIN PWB

SFV-1065A-M2
[AV-27220/S]

SFV-1066A-M2
[AV-27220/R]

NOTE

41	BRIDGE/COMP	IN	RESistor
42	BRIDGE/COMP	OPT	NON-HEATSHRINK
43	STANDARD	OPT	SAFETY PARTS
44	STANDARD	IN	OF RESISTOR
45	BRIDGE/COMP	IN	DIFFERENCE PARTS
46	WALA-10-12		
47	WALA-10-12		
48	WALA-10-12		
49	BRIDGE/COMP		

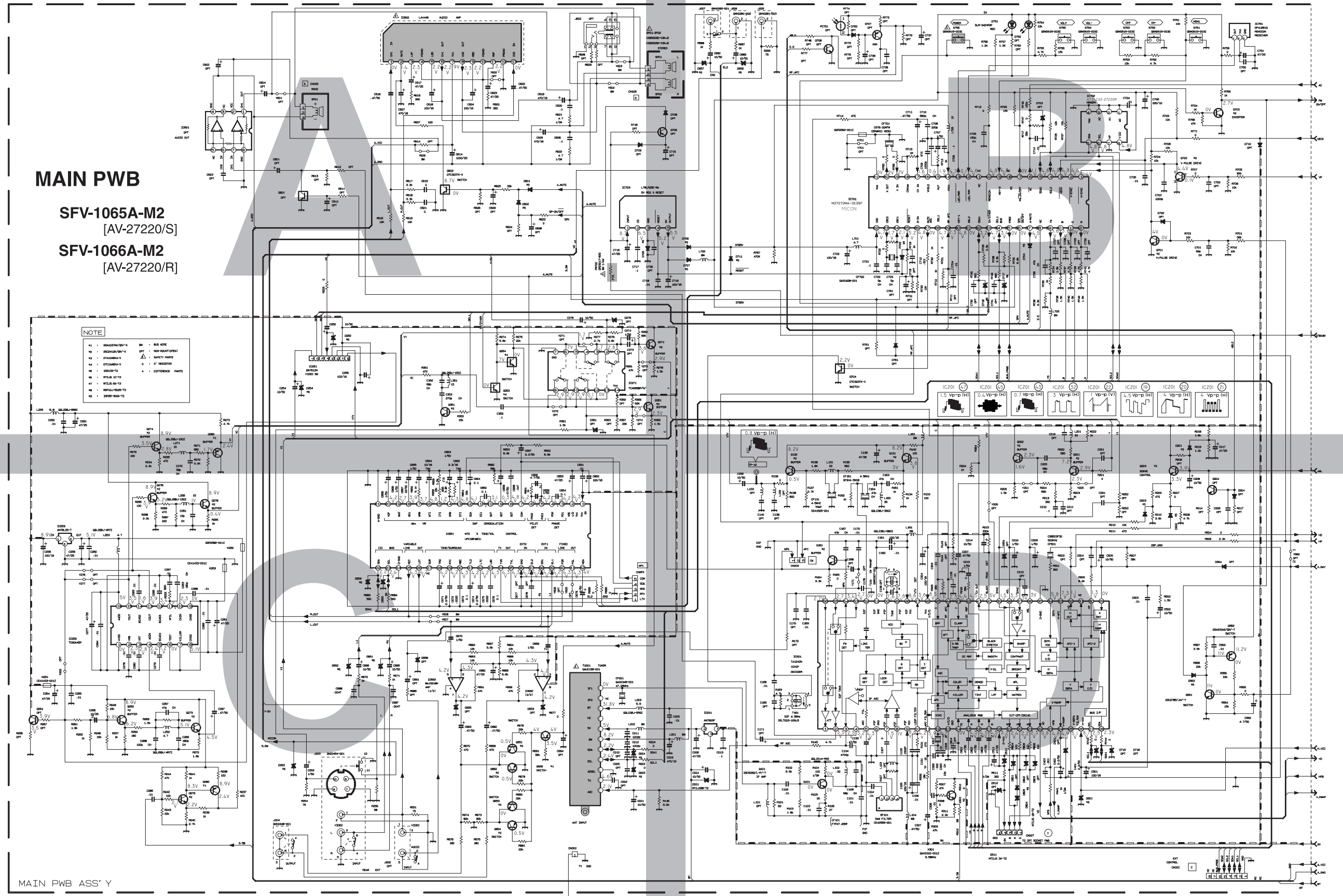

MAIN PWB ASS'Y

(C See,Page 2-11,2-12)

(D See,Page 2-13,2-14)

A

MAIN PWB

SFV-1065A-M2 [AV-27220/S]

SFV-1066A-M2 [AV-27220/R]

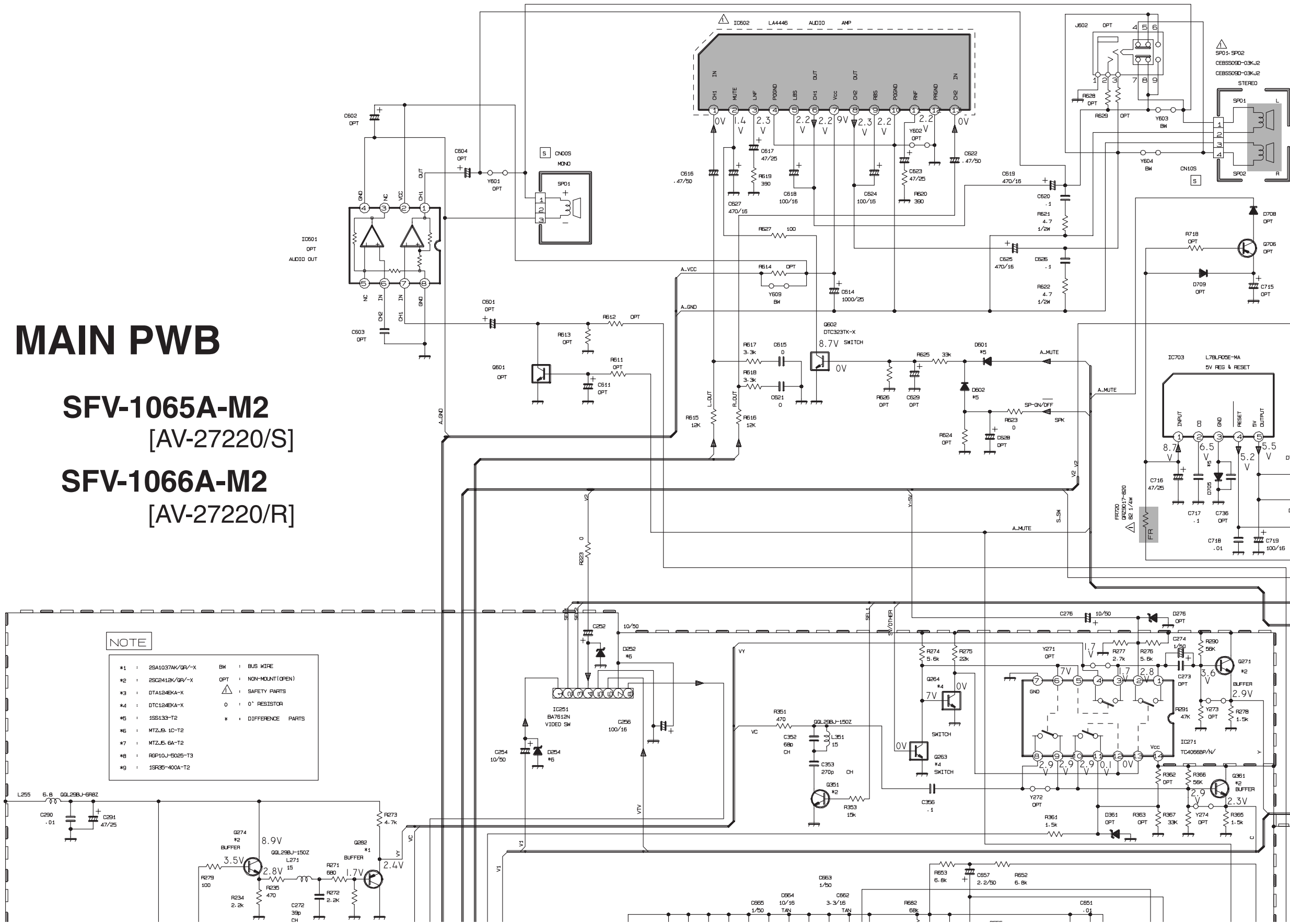

- NOTE**
- *1 : 2SA1037AK/GR-X BW : BUS WIRE
 - *2 : 2SC2412K/GR-X OPT : NON-MOUNT (OPEN)
 - *3 : DT1A124KA-X Δ : SAFETY PARTS
 - *4 : DTC124KA-X ○ : 0th RESISTOR
 - *5 : 1SS133-T2 * : DIFFERENCE PARTS
 - *6 : MTZL5-1C-T2
 - *7 : MTZL5-6A-T2
 - *8 : R6P10J-5025-T3
 - *9 : 1SR35-400A-T2

B

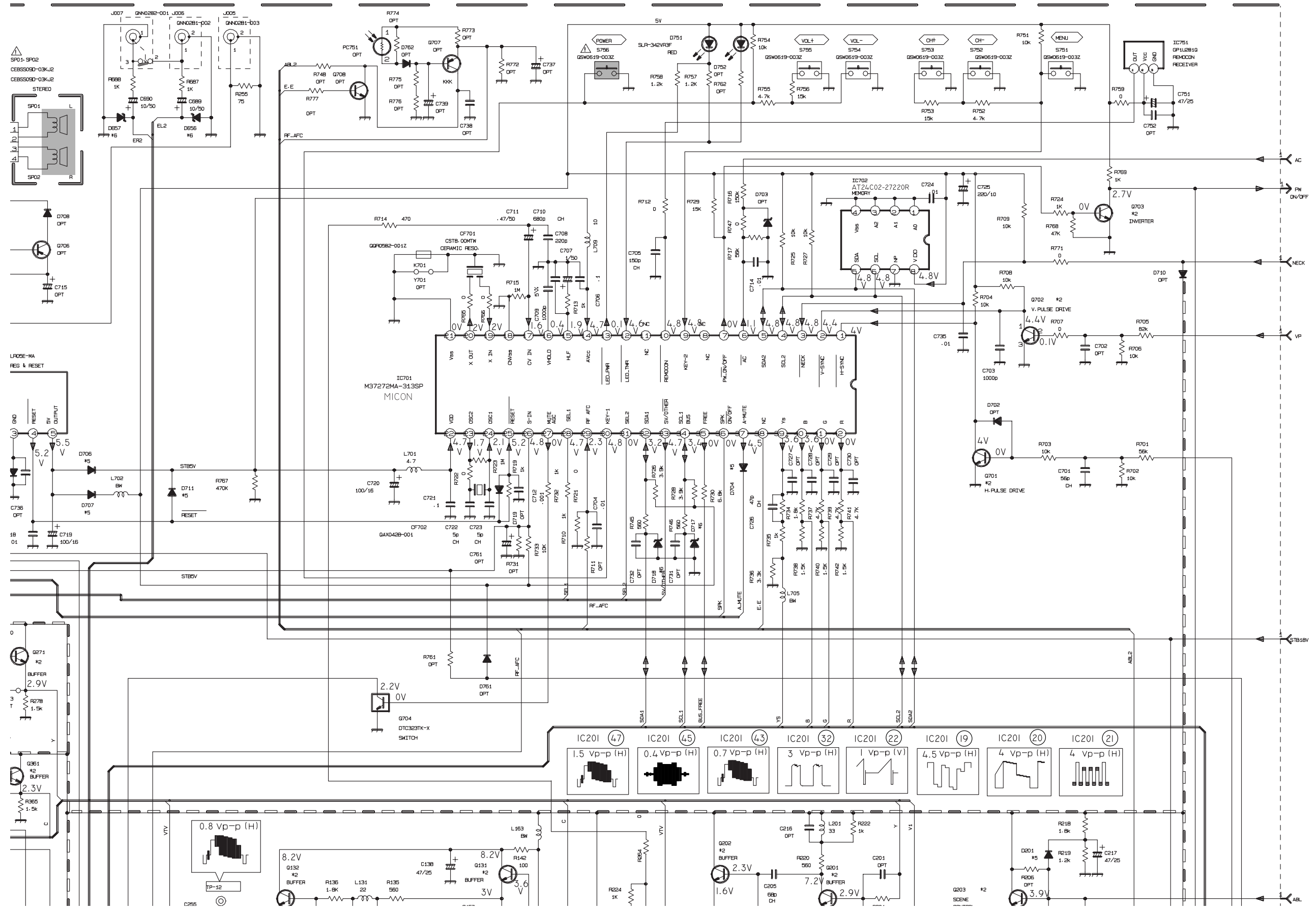

C

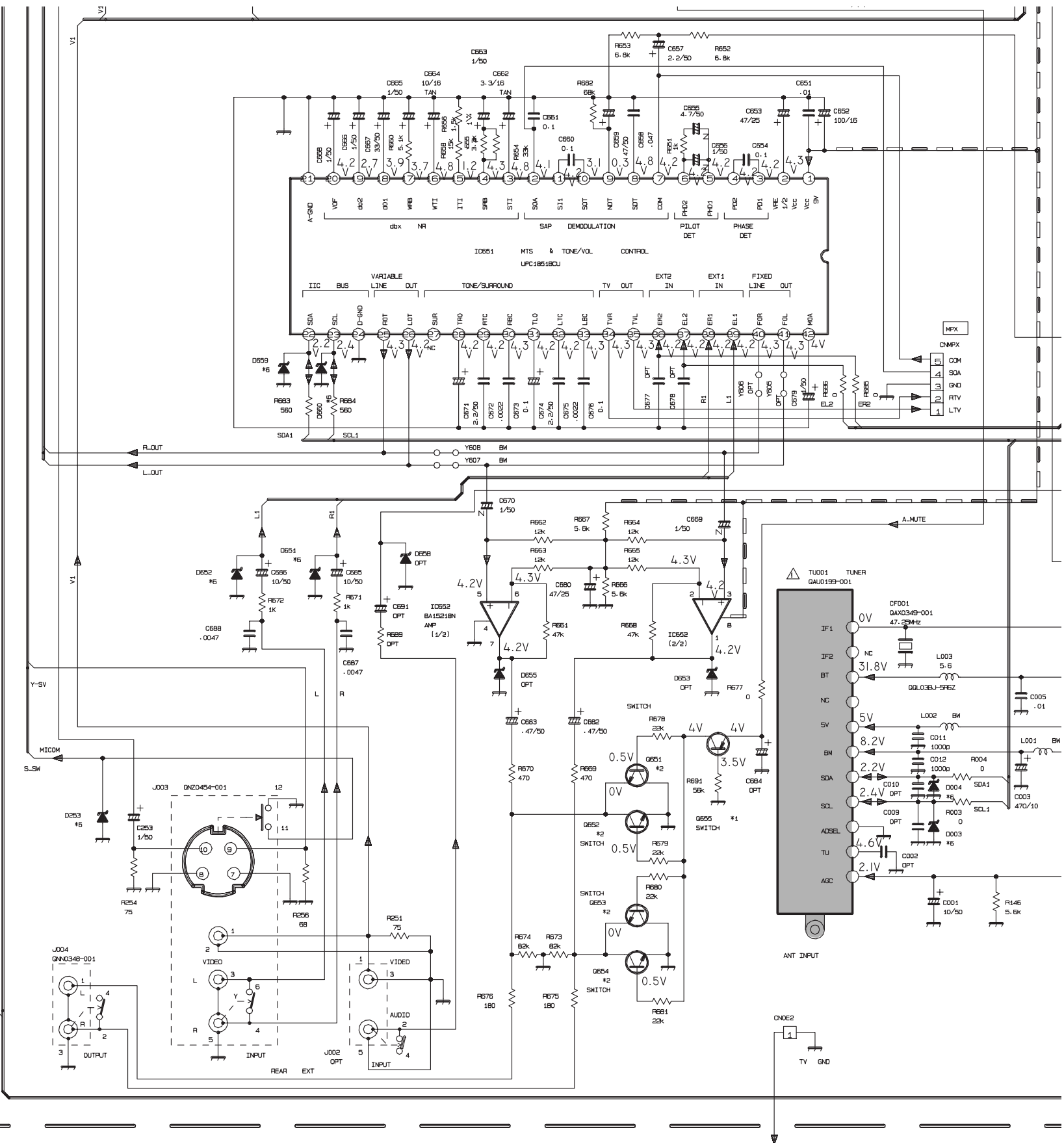
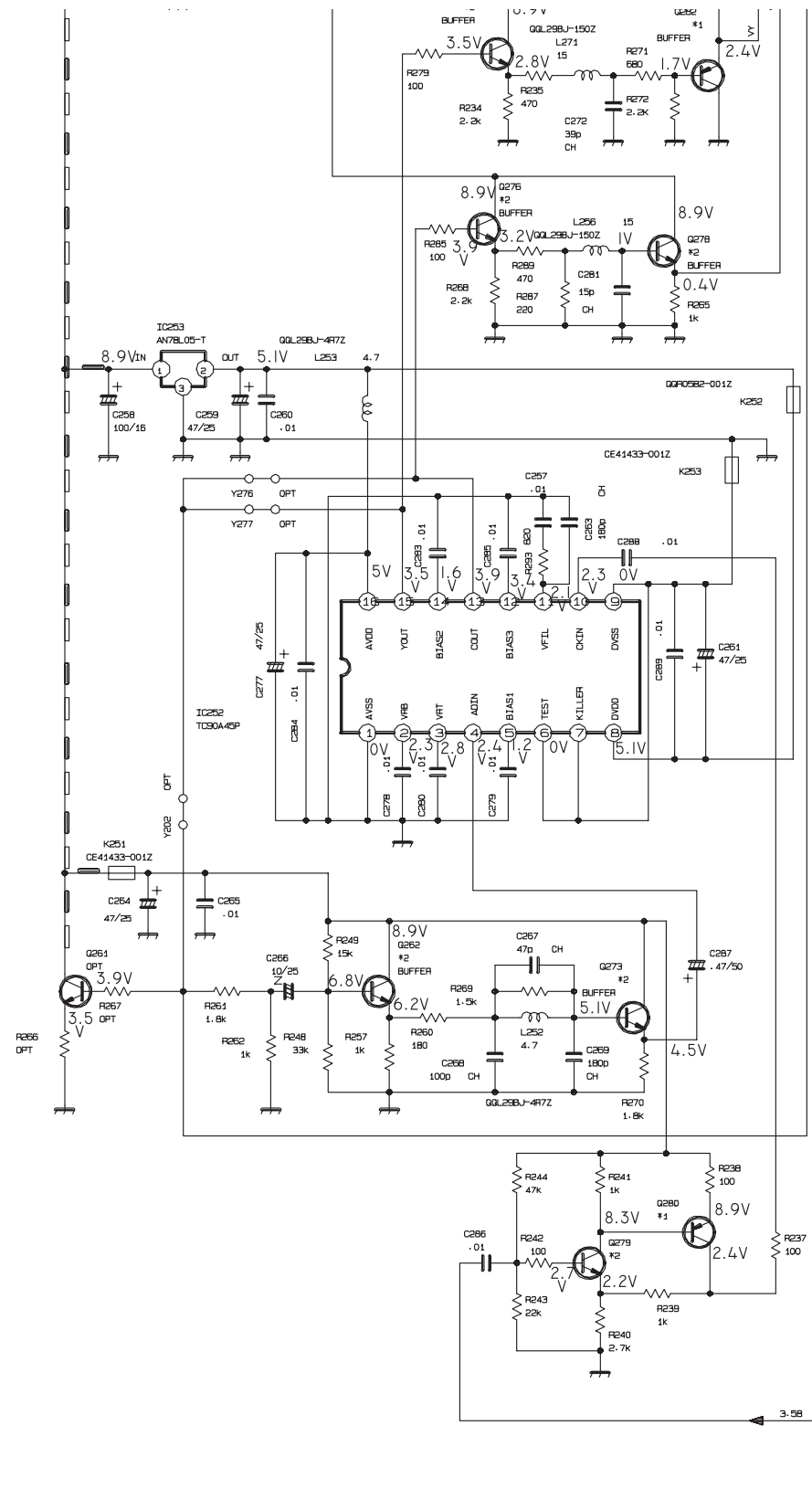

MAIN PWB ASS'Y

D

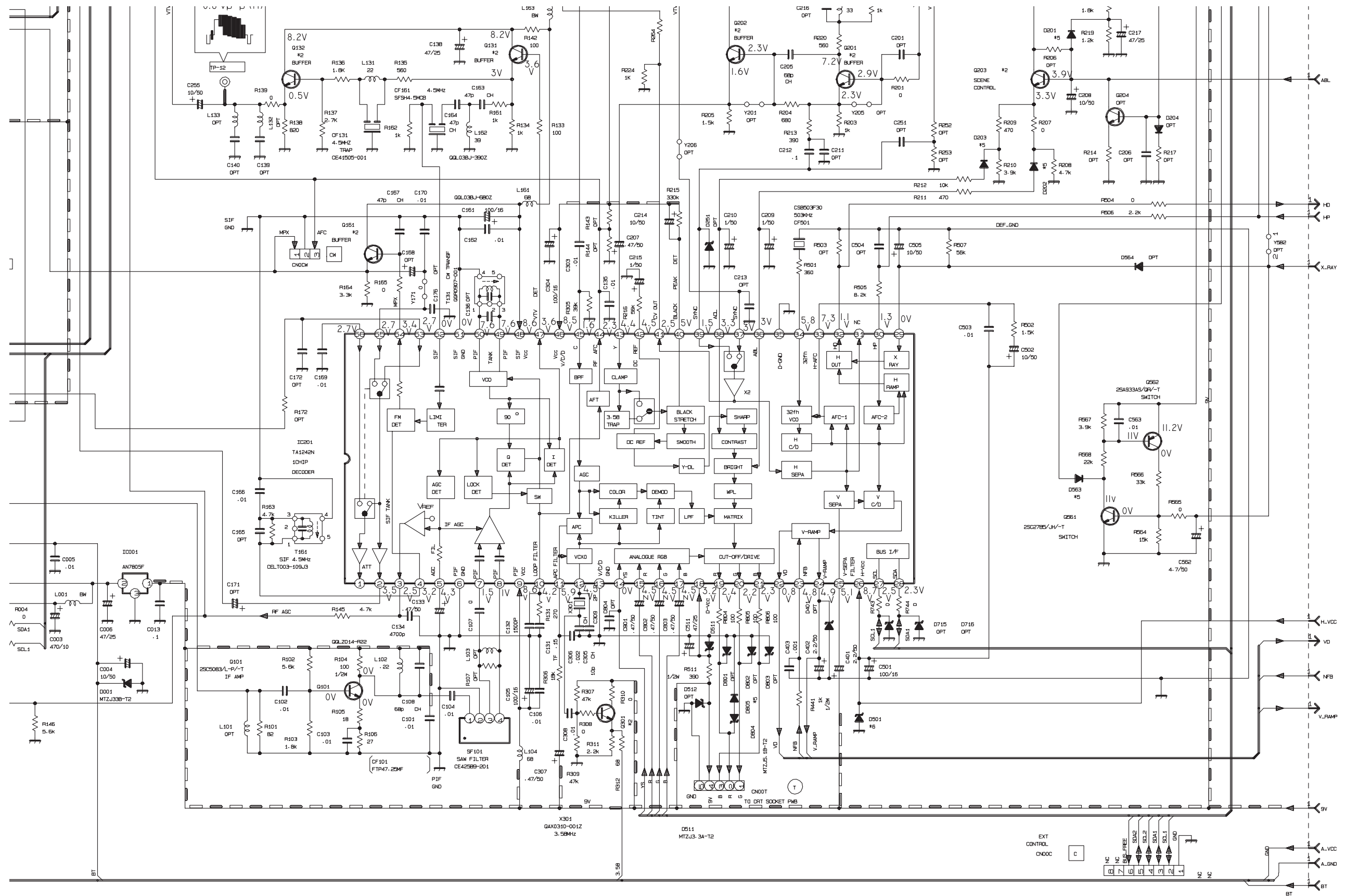

MAIN PWB, CRT SOCKET PWB CIRCUIT DIAGRAM

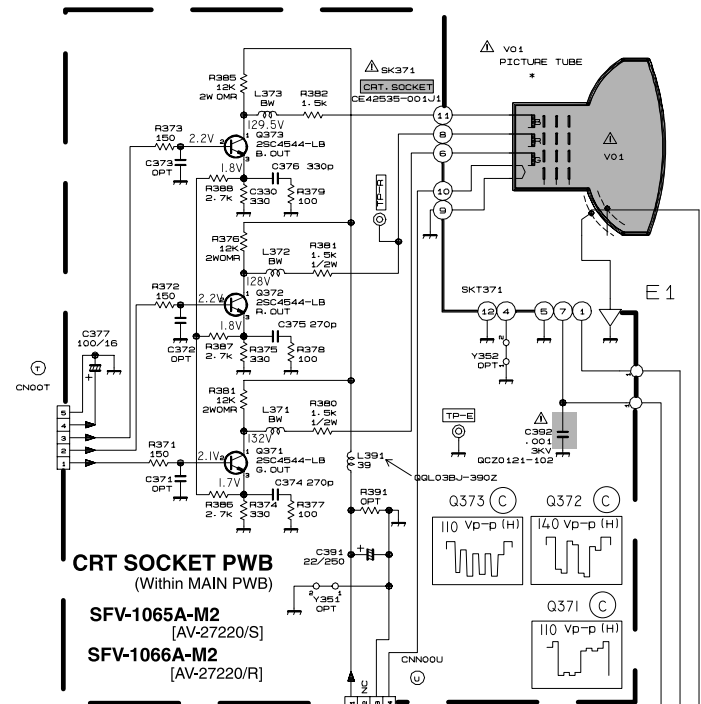
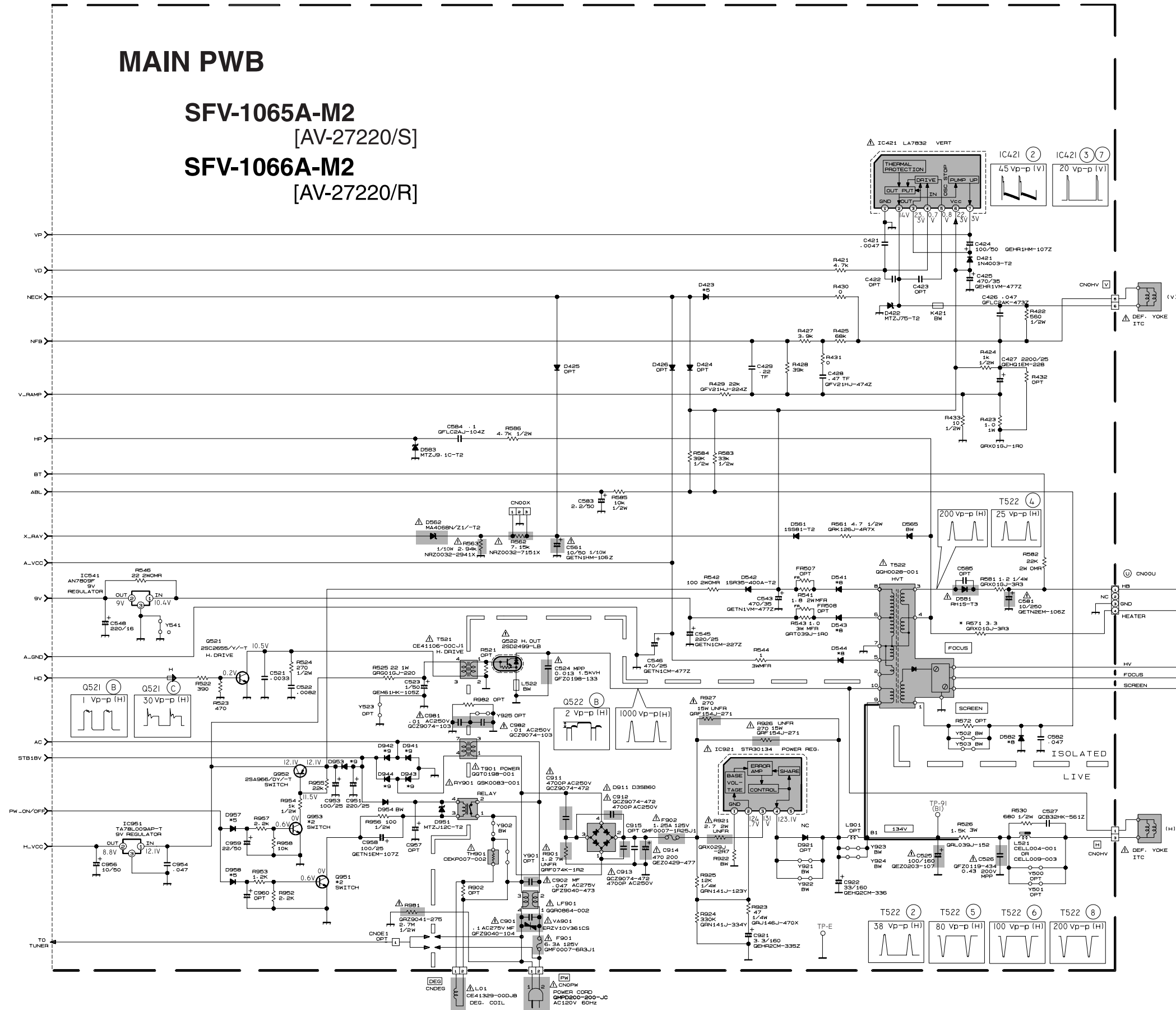

***DIFFERENCE LIST**

	SFV-1065A-M2	SFV-1066A-M2
V01	A660C891X00	A66AD25X01
R571	GRX01GJ-3R3	GRX01GJ-1R5

NOTE

- *1 : 2SA1037AK/GR/-X BW : BUS WIRE
- *2 : 2SC2412K/GR/-X OPT : NON-MOUNT (OPEN)
- *3 : DT124EK-A-X Δ : SAFETY PARTS
- *4 : DTC124EK-A-X 0 : 0 RESISTOR
- *5 : 1S5133-T2 * : DIFFERENCE PARTS
- *6 : MTZJ5-1C-T2
- *7 : MTZJ5-6A-T2
- *8 : R9P10J-502B-T3
- *9 : 19R35-400A-T2

JVC SERVICE & ENGINEERING COMPANY OF AMERICA
DIVISION OF JVC AMERICAS CORP.

Head office : 1700 Valley Road, Wayne, New Jersey 07470 (973)315-5000
East Coast : 10 New Maple Avenue, Pine Brook, New Jersey 07058 (973)396-1000
Midwest : 705 Enterprise St. Aurora, Illinois 60504 (630)851-7855
West Coast : 5665 Corporate Avenue, Cypress, California 90630 (714)229-8011
Southwest : 10700 Hammerly, Suite 105, Houston, Texas 77043 (713)935-9331
Hawaii : 2969 Mapunapuna Place, Honolulu, Hawaii 96819 (808)833-5828
Southeast : 1500 Lakes Parkway, Lawrenceville, Georgia 30243 (770)339-2582

JVC CANADA INC.

Head office : 21 Finchdene Square Scarborough, Ontario M1X 1A7 (416)293-1311
Vancouver : 13040 Worster Court Richmond B.C. V6V 2B3 (604)270-1311

JVC[®]